

Science and everyday observation
confirm the existence of God

Top 15 Evidences for God and Creation – part 1

June 23, 2012 PEW Survey

« Homepage **CNN**

WATCH MORE ► Collections Shows Live TV Search videos

Questioning God's existence

CNN | Added on June 23, 2012

Share this Tweet this

CNN's Don Lemon reports on why more younger people in the U.S. are questioning the existence of God.

PEW RESEARCH SURVEY
I NEVER DOUBT THE EXISTENCE OF GOD. AGREE OR DISAGREE?

2012:	68%	OF AMERICANS 30 YEARS AND YOUNGER NEVER DOUBT GOD'S EXISTENCE
2007:	83%	OF AMERICANS 30 YEARS AND YOUNGER NEVER DOUBT GOD'S EXISTENCE

Source: Pew Research Center Survey

NEWS ROOM CNN

Evolution in the news...

“evolution is not something one ‘believes’ in, any more than one ‘believes’ in Newton’s law of gravity. Evolution is not a matter of faith, but of well-demonstrated fact.”

Asbury Park Press editorial, May 22, 2012

Richard Dawkin's says...

**“The factual premise of religion
– the God Hypothesis –
is untenable.
God almost certainly does not exist.”**



And again...

“Faith is the great cop-out, the great excuse to evade the need to think and evaluate evidence. Faith is belief in spite of ... the lack of evidence [for God].”

Only two views of reality

God

■ IS

- He created the universe and us
- The Bible and Christianity

■ ISN'T

- A natural process of evolution must have taken place
- Religion is man-made

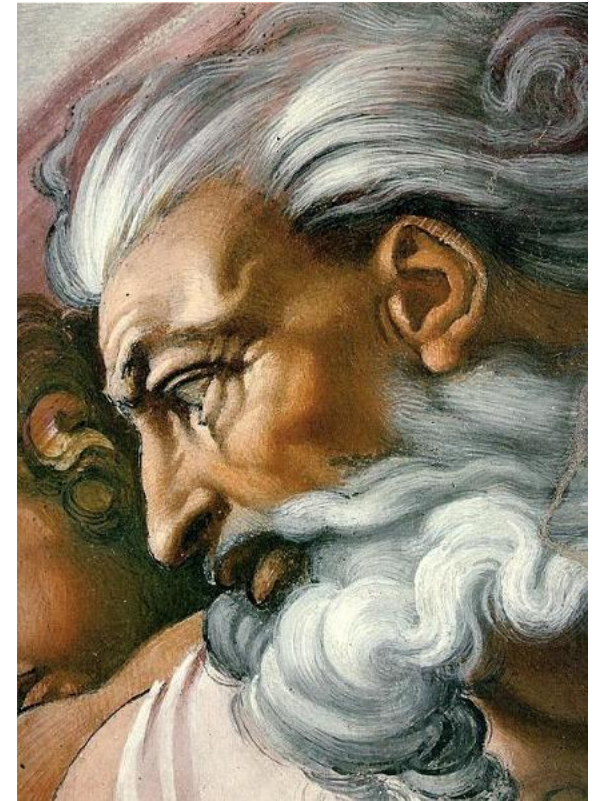

What is the ultimate reality?

Mind	Matter
Is conscious and self-aware	Is not
Can think and reason	Cannot
Can love	Cannot

If God is not real we are wasting our time!

And if Christ has not been raised [that is, there is no biblical creator God capable of raising the dead], **your faith is futile**; you are still in your sins.

1 Corinthians 15:17

What does the evidence support?

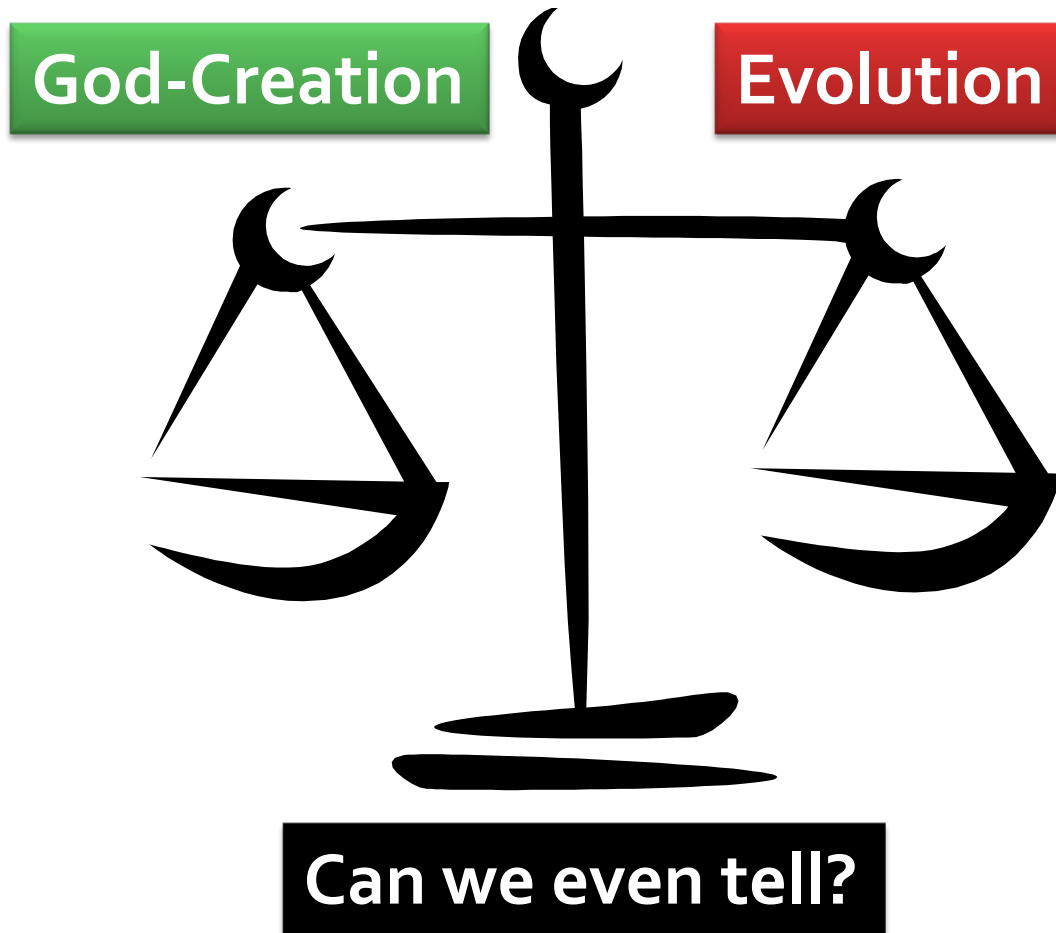

The evolutionist says

Evolution

God-Creation

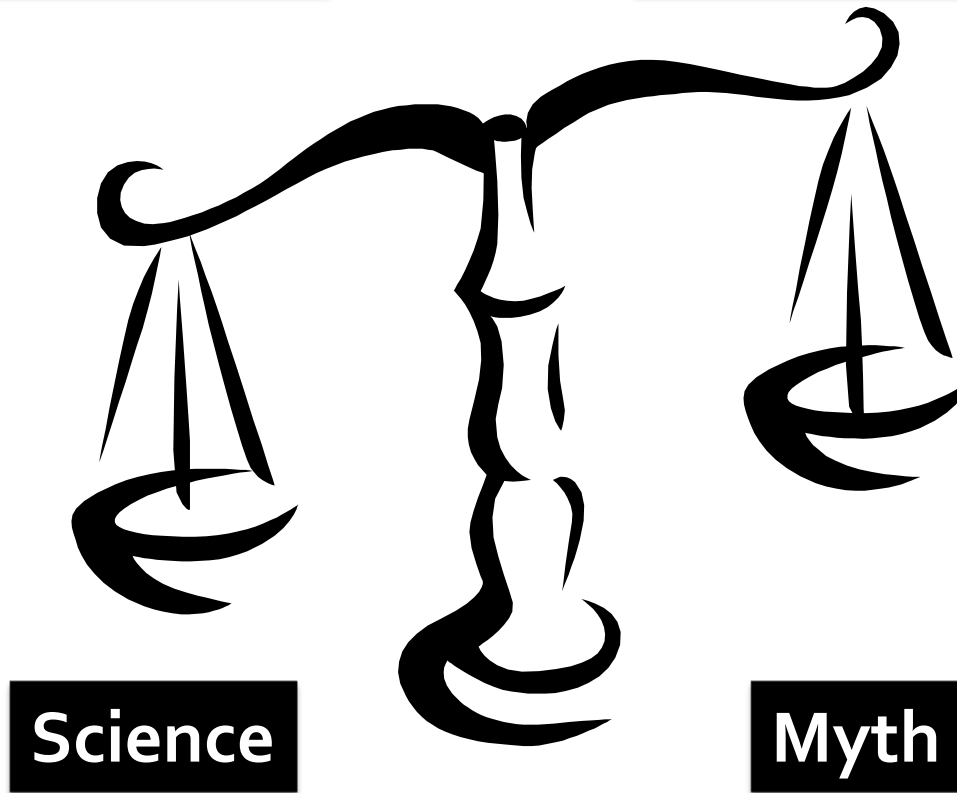

Top evidences for God are...

- BIG (large-scale) concepts
- Fundamental concepts
- Timeless arguments –
not dependent on the latest
scientific findings

Top Evidences for God and Creation

1. The Bible's Witness
2. Information
3. Formation of First Life
4. Design and Beauty of Living Things
5. Second Law of Thermodynamics
6. Irreducible Complexity

Part 1

7. Existence of the Universe
8. Fine-tuning of Physics
9. Fine-tuning of Earth for Life
10. Abrupt Appearance in the Fossil Record
11. Human Consciousness and Language
12. Human Reasoning and Logic
13. Sexual Reproduction
14. Morality
15. Miracles

Part 2

Part 1

God speaks through both

- 1. Special revelation (the Bible)**
 - 2. General revelation (nature)**
-

#1: The Bible's Witness

- The Bible does not try to prove that God exists, for this knowledge is written on our hearts
- Both the Bible and creation show us God
- Prophecies fulfilled attest to the truth of the Bible
- The martyrdom of the Apostles attests to the resurrection of Jesus and the truth of the Bible
- God was the only one there in the beginning when the universe was created
- The Bible is not a book of science but it is a book of history

To the roots of the mountains I sank down
Jonah 2:6



**Jonah (860 B.C.) describes that there
are mountains under the ocean!**

<http://www.readeratwork.net/fly-down-into-the-marianas-trench.html>

Prophecy (Isaiah 52:13-53)

Isaiah foretold of Christ 700 years before His birth:

- **He was despised and rejected by men (52:3)**
- **he took up our infirmities
and carried our sorrows (4)**
- **he was pierced for our transgressions,
he was crushed for our iniquities (5)**
- **He was oppressed and afflicted,
yet he did not open his mouth;
he was led like a lamb to the slaughter (7)**
- **After the suffering of his soul,
he will see the light of life and be satisfied (11)**
- **For he bore the sin of many (12)**

Martyrdom of the Apostles

Apostle	How Died
<i>Matthew</i>	Killed by sword
<i>Mark</i>	Dragged by horses
<i>Peter</i>	Crucified upside down
<i>James (Jesus half-brother)</i>	Thrown off temple and clubbed
<i>James (son of Zebedee)</i>	Beheaded
<i>Bartholomew</i>	Flayed by a whip
<i>Andrew</i>	Crucified
<i>Thomas</i>	Stabbed with spear
<i>Jude</i>	Killed by arrows
<i>Matthias</i>	Stoned and beheaded
<i>Paul</i>	Beheaded
<i>Luke</i>	Hanged
<i>John</i>	Boiled in oil but lived – sentenced to prison island

Who would die
for a known lie?

Romans 1:20-25

For since the creation of the world God's invisible qualities—his eternal power and divine nature—have been clearly seen, being understood from what has been made, so that **men are without excuse.** For although they knew God, they neither glorified him as God nor gave thanks to him, but their thinking became futile and their foolish hearts were darkened. Although they claimed to be wise, they became fools ... They exchanged the truth of God for a lie, and worshiped and served created things rather than the Creator.

What is more trustworthy?

- **Scientific theories of man**
 - Always changing
 - Based on a worldview of naturalism (there is no God)
- **The Bible**
 - Unchanging
 - Inspired by the Spirit of God

**We must develop science based on a biblical worldview,
not interpret the Bible to match current science**

Psalms 19:1-4 The heavens declare the glory of God; the skies proclaim the work of his hands. Day after day they pour forth speech; night after night they display knowledge. There is no speech or language where their voice is not heard. Their voice goes out into all the earth, their words to the ends of the world.



Horsehead Nebula (www.nasa.gov)



#2: Information

- Life is based on information
- Information always comes from a mind
- Information can never arise from a physical process alone (like evolution)
- The information for life (the DNA) came from the mind of God

What is Information?

- **Information = knowledge or instructions; a blueprint**
- **The more complex something is, the more information it contains**
 - **More words are needed to describe it**
 - **Longer instructions are needed to build it**
- **The information for how to build, operate, and repair life is coded in the DNA of the genome**

It all comes down to "information"

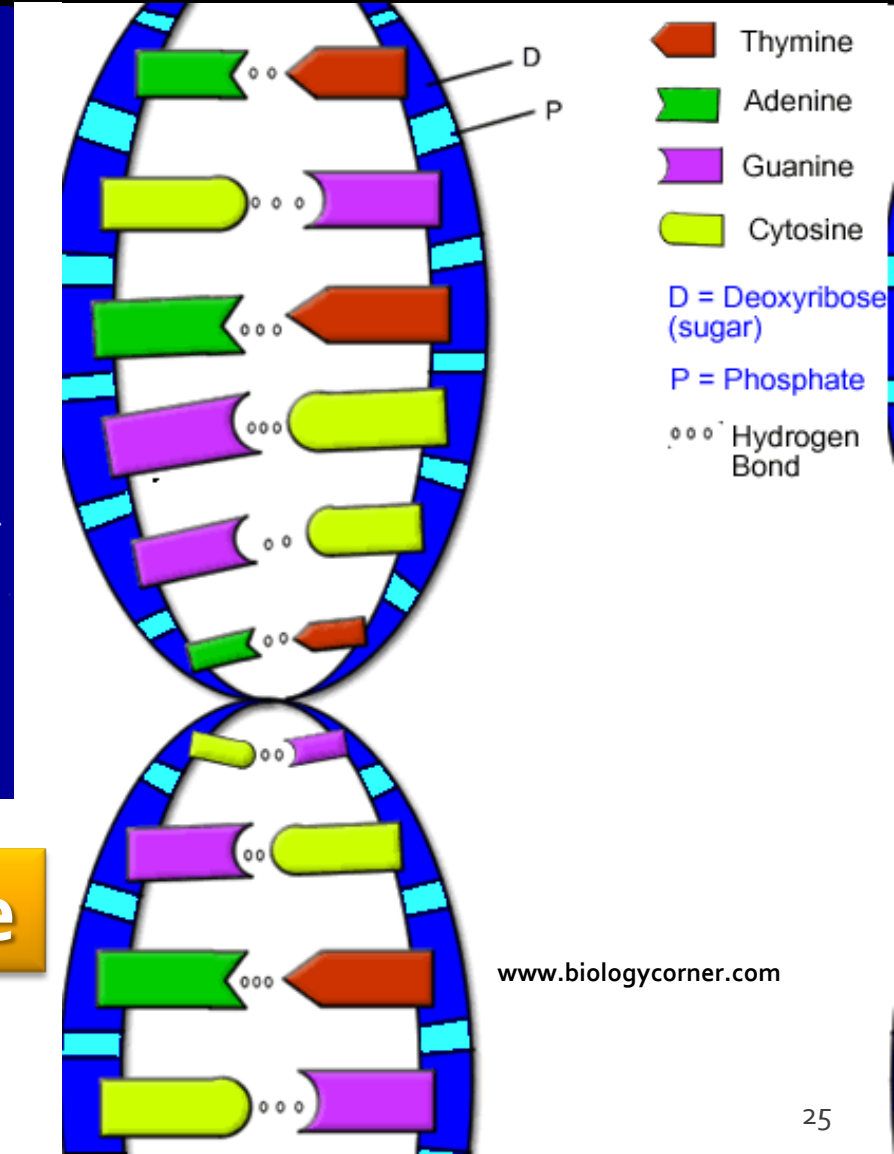
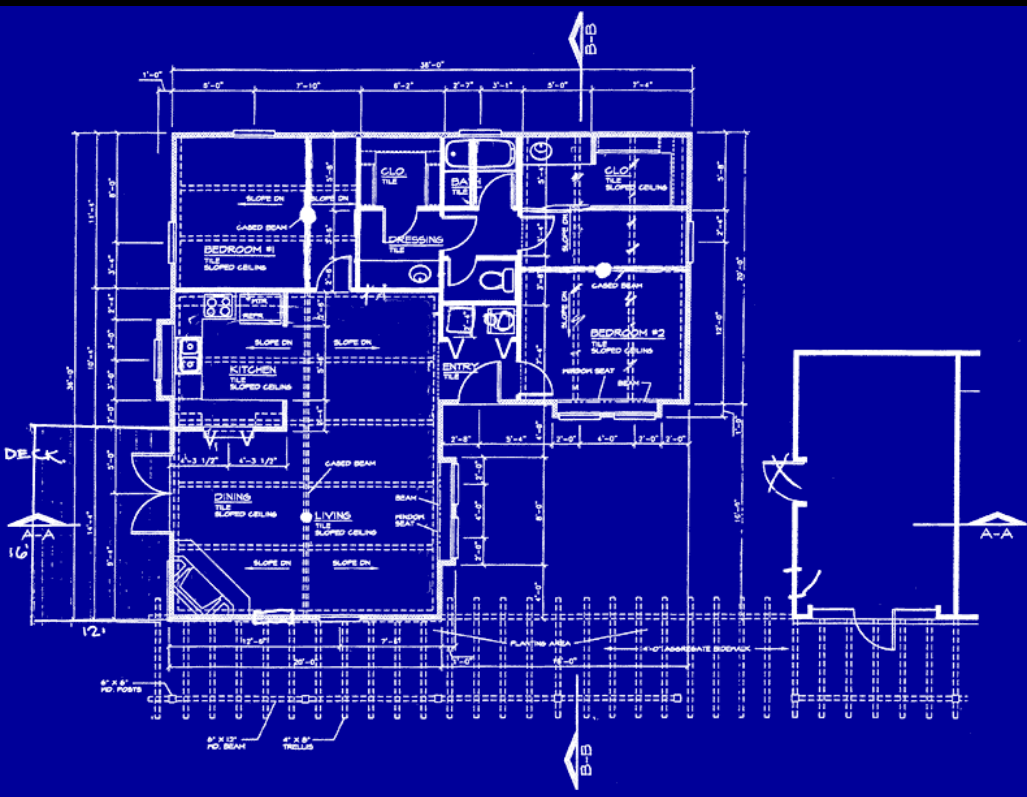

DNA is the blueprint of life

www.biologycorner.com

DNA Sequencing Result

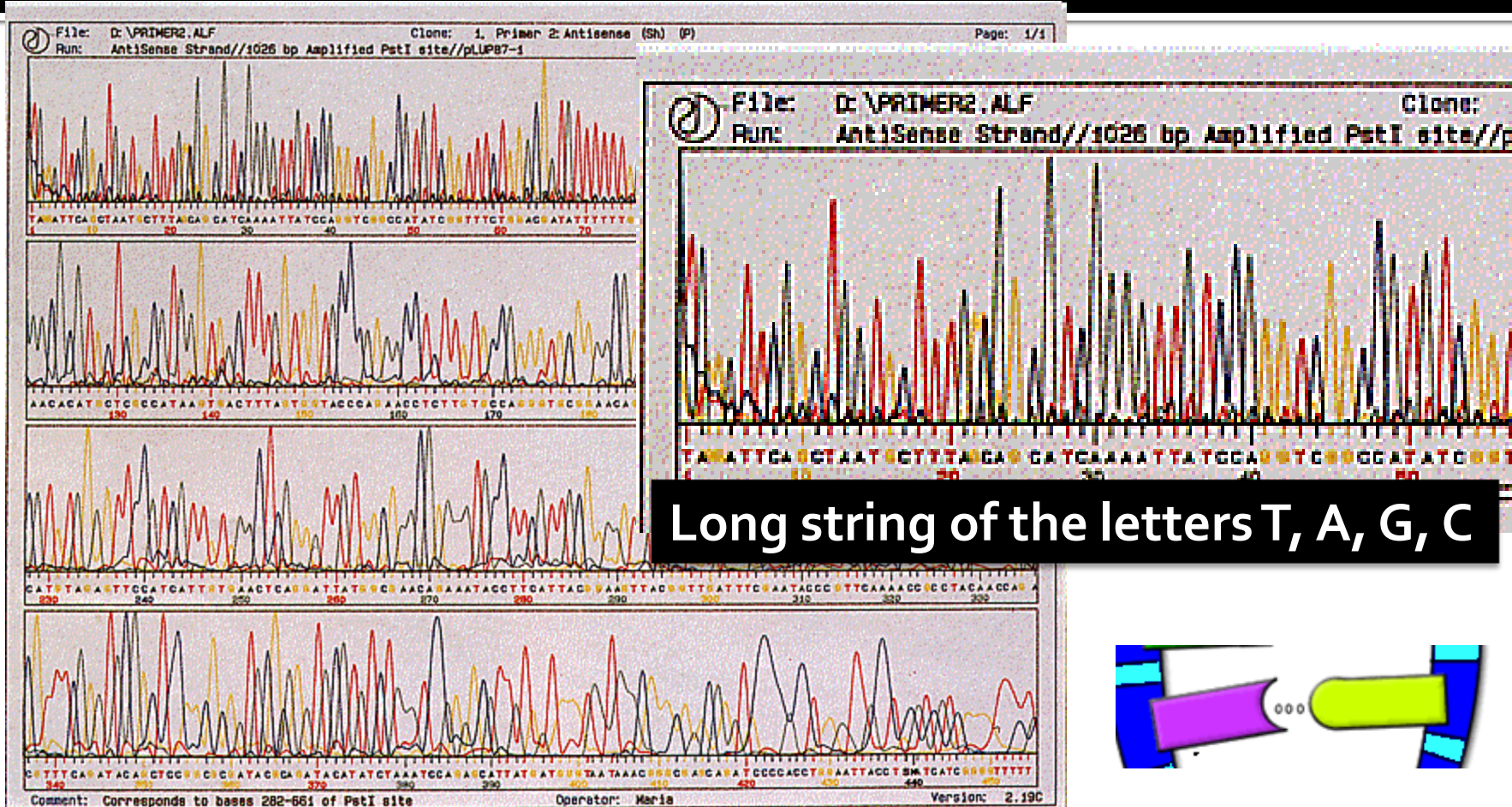

Your genome has 3 billion base pairs

How is Evolution Supposed to Work

Darwin's mechanism: evolution is caused by:

- **1. Spontaneous variation (mutation) +**
- **2. Differential reproduction (natural selection)**

If evolution is true, Darwin's mechanism must have caused the development of the genetic information that builds, operates, and repairs all living things

What is Meant by “Selection”?

“Natural Selection” (“selection” for short):

- 1. Eliminates some of the least fit individuals and their bad mutations (they don't stay alive to reproduce)**
- 2. Favors the reproduction of some of the most fit individuals and their beneficial mutations**

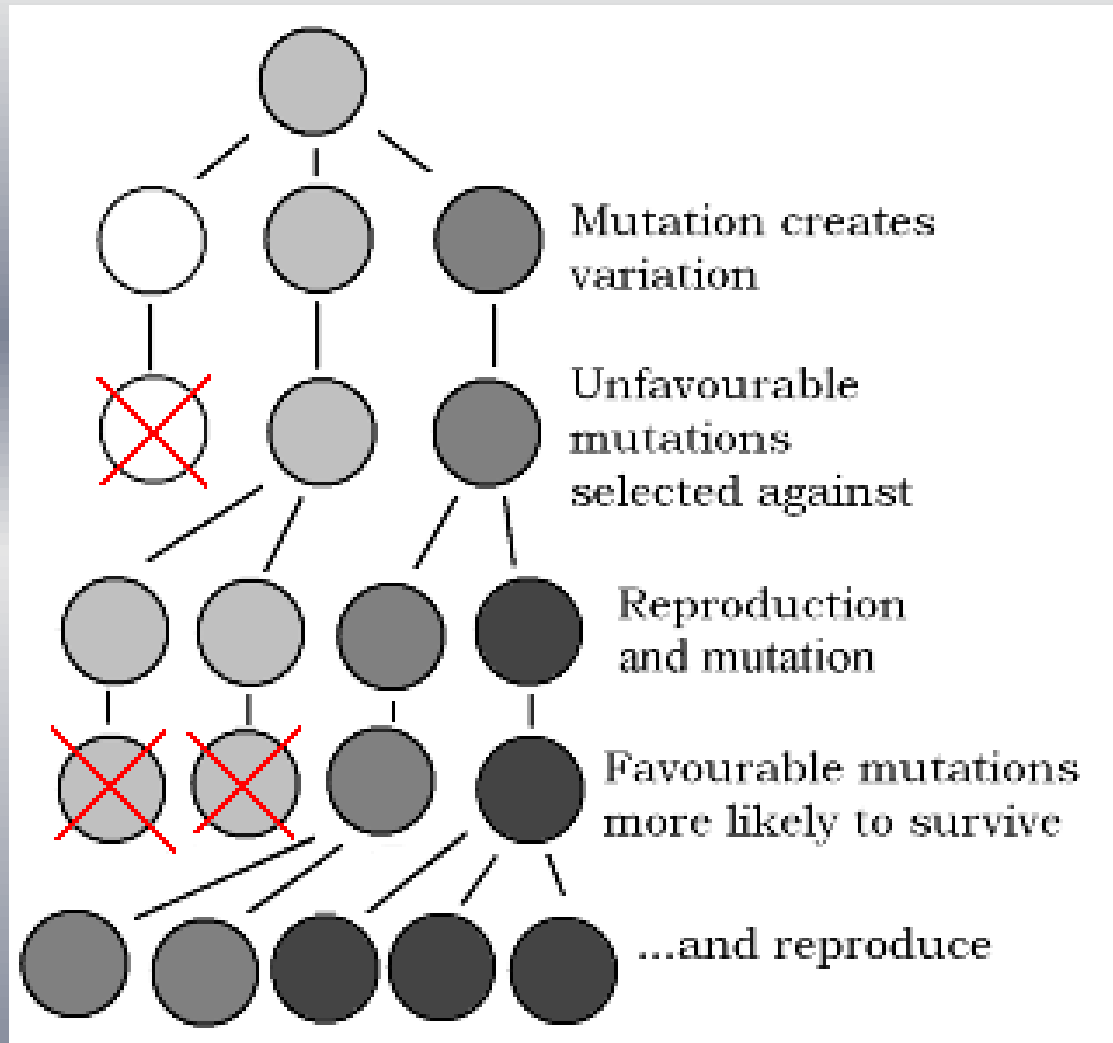

EvoWiki.org

Natural Selection is True – it is NOT Evolution

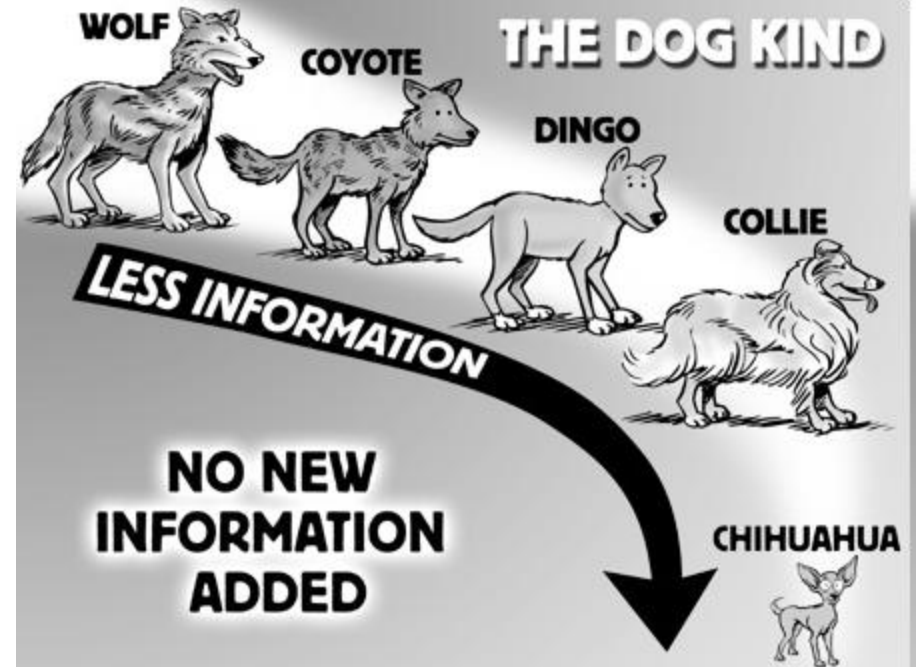
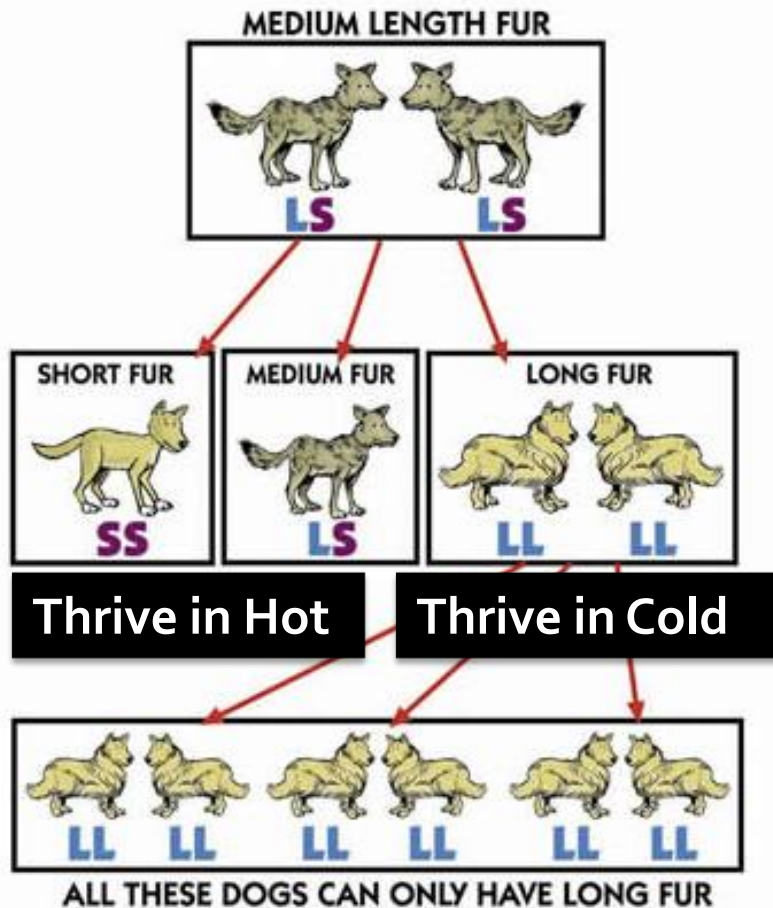

Answersingenesi.org

Natural selection selects from already existing information and causes a loss of information

Information is a mental concept

We must not confuse the physical representation of information (e.g. DNA) with the information itself!

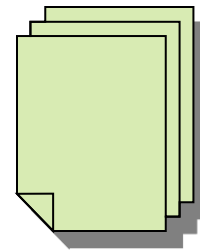
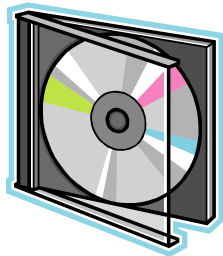

The information content in this PowerPoint is the same:

- **Stored on a computer hard-drive**
- **Stored on a CD**
- **Viewed on a screen**
- **Printed on paper**
- **Read to you by someone**





Scratching a CD will not
make a better song

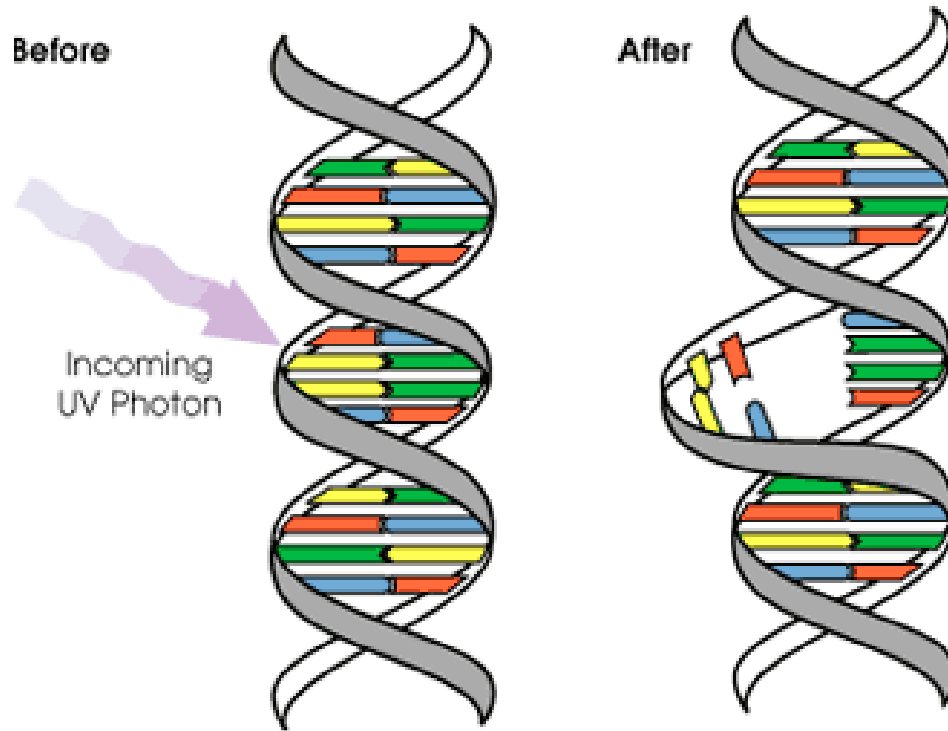

Whyfiles.org

Yet mutating the DNA has supposedly made better organisms!

Evolutionary vs. Creation Views of Information

Evolutionary View

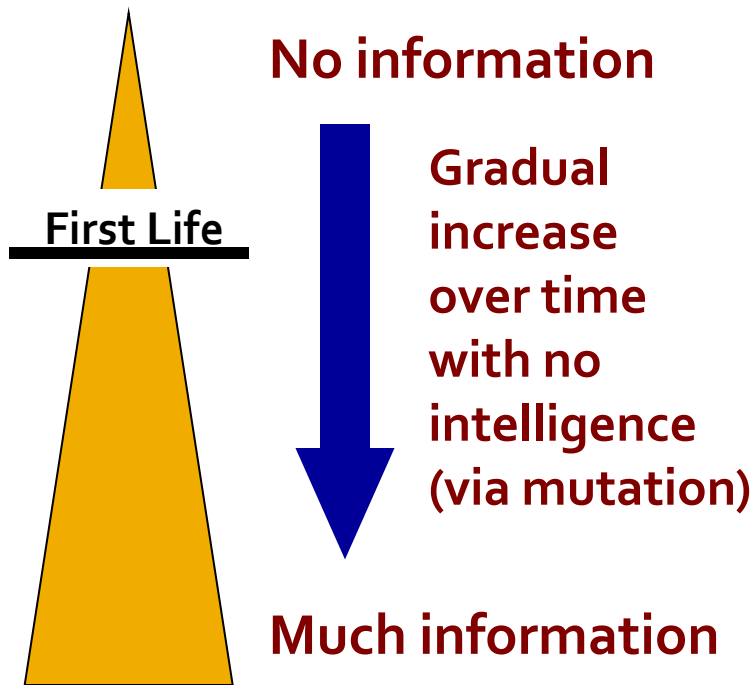

Note: mutation / natural selection only operates after the first replicating life form exists

Creation View

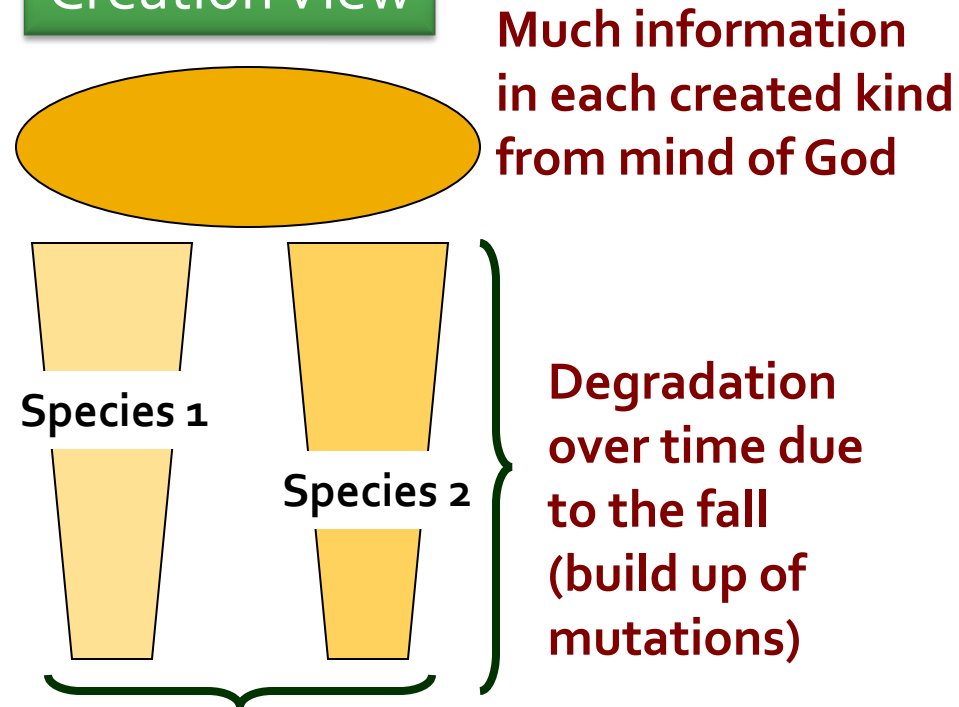

Kind diversifies into species due to environmental differences expressing different subsets of existing information

The DNA information problem

- **“DNA is like a computer program but far, far more advanced than any software ever created” -- Bill Gates**
- **“The problem of the origin of life is clearly basically equivalent to the problem of the origin of biological information” -- Origin-of-life researcher Bernd-Olaf Koppers**

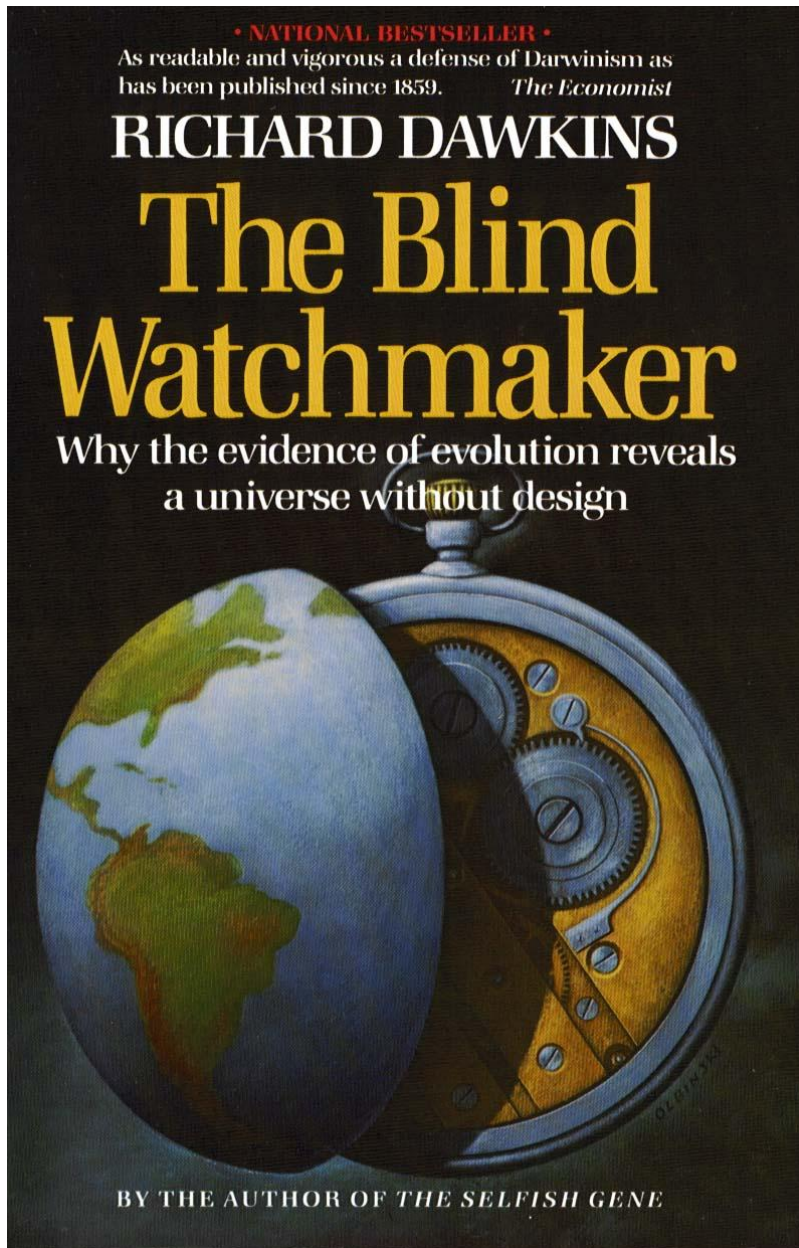

“Biology is the study of complicated things that give the appearance of having been designed for a purpose” (pg. 1)

The Blind Watchmaker

- Richard Dawkins makes the claim that “cumulative selection” is the source of information creation in evolution
- “In cumulative selection ... the results of one sieving process are fed into a subsequent sieving. The end product of one generation of selection is the starting point for the next generation of selection, and so on for many generations.”

Dawkins's example:

Initial sequence:

WDLMNLT DTJBKWIRZREZLMQCO P

Predetermined target sentence:

METHINKS IT IS LIKE A WEASEL

First test:

Gen. 01 WDLMNLT DTJBKWIRZREZLMQCO P

Gen. 02 WDLTMNLT DTJBSWIRZREZLMQLO P

Gen. 10 MDLDMNLS ITJISWHRZREZ MECS P

Gen. 20 MELDINLS IT ISWPRKE Z WECSEL

Gen. 30 METHINGS IT ISWLIKE B WECSEL

Gen. 40 METHINKS IT IS LIKE I WEASEL

Gen. 43 METHINKS IT IS LIKE A WEASEL

Why “Cumulative Selection” Doesn’t Work

- The target sentence has been predetermined! - evolution has no predetermined target in mind
 - The information is already present from the beginning and no new information has been created
- The existence of a reproducing life form (the initial string) is assumed, but it takes much information to get to this point
- Letters in the correct position are just as likely to be mutated (changed to a different letter)
- Information is much more than just letters in the right spot – it must be recognized and used for a purpose

Conclusions from information

- Life is based on information
 - Information always comes from a mind
 - Information can NEVER arise from a physical process (like evolution)
- The information of life came from the mind of God!

#3: Formation of First Life

- Spontaneous generation is impossible
- The cell is a complex miniature factory not a simple blob of chemicals
- Numerous experiments to create life have all failed
- Even the simplest life requires tremendous information to be present

The cell – a miniature factory

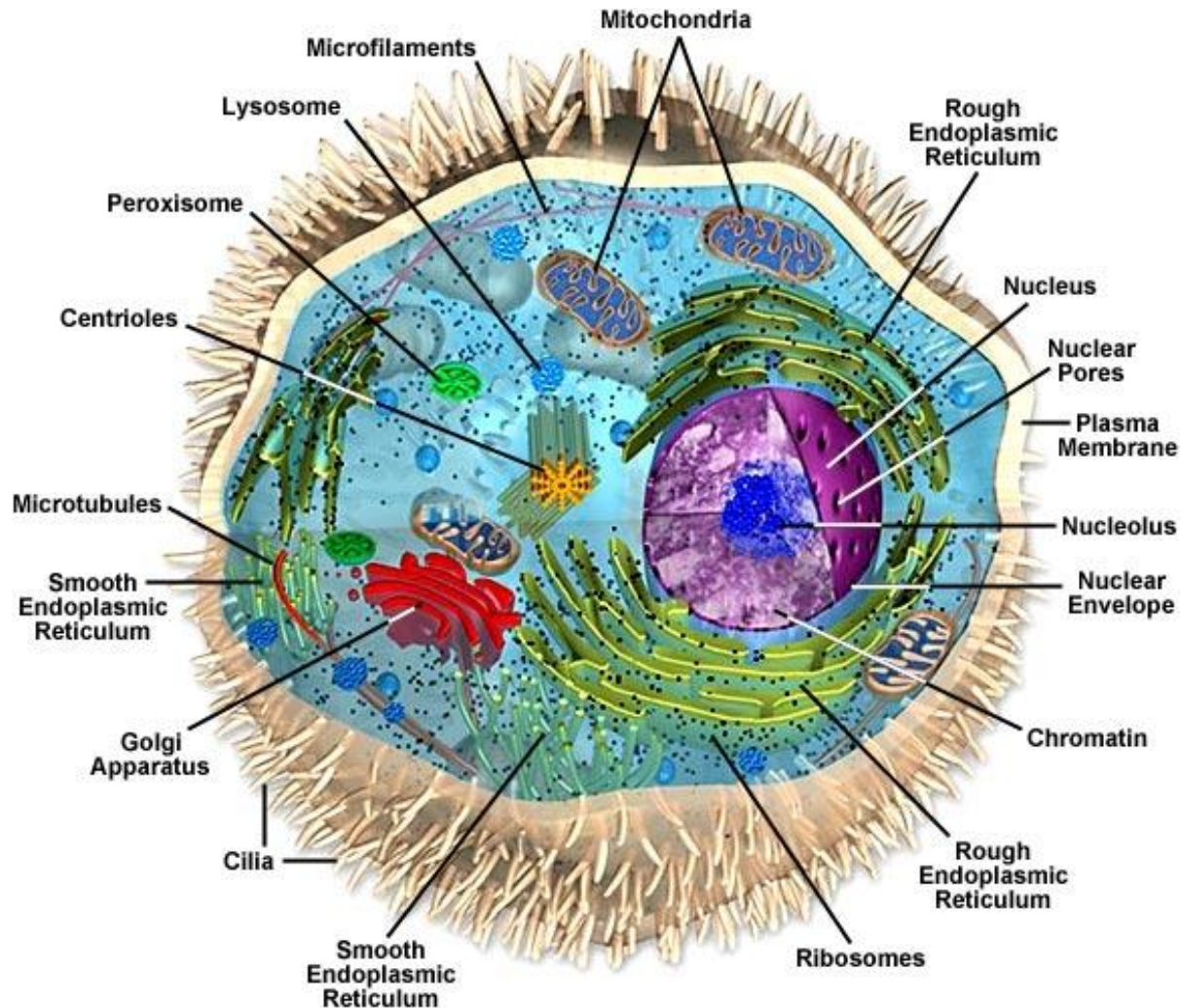

Molecular machines

The kinesin motor protein

Nano-tugboat. A kinesin molecule "walks" along a biopolymer "track" by alternately attaching and disconnecting each of two "feet," hauling cellular cargo in its wake

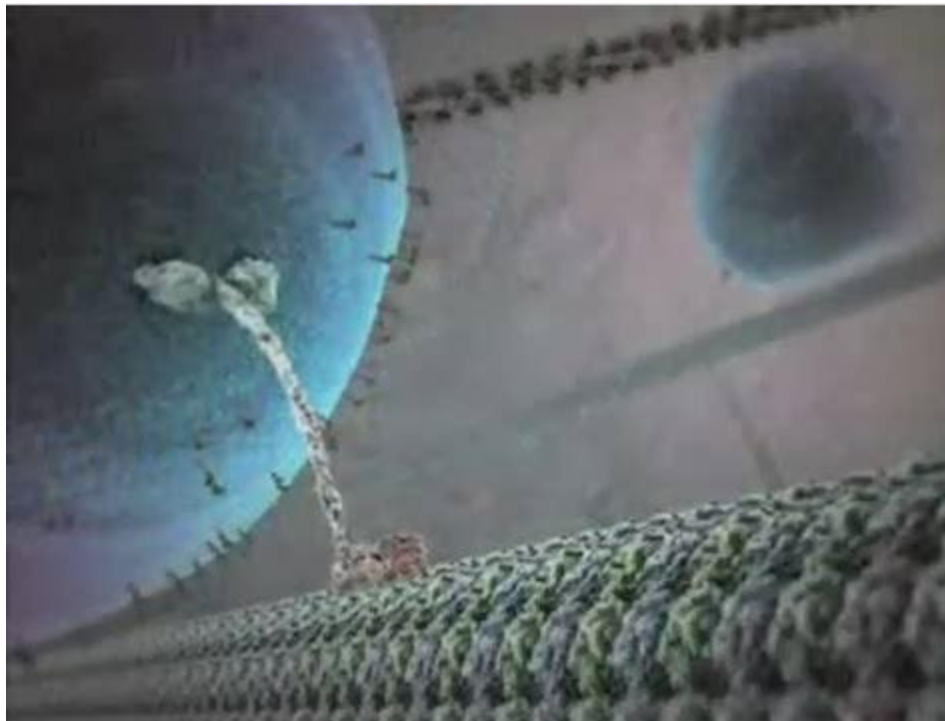

Molecular machines

The bacterial flagellum

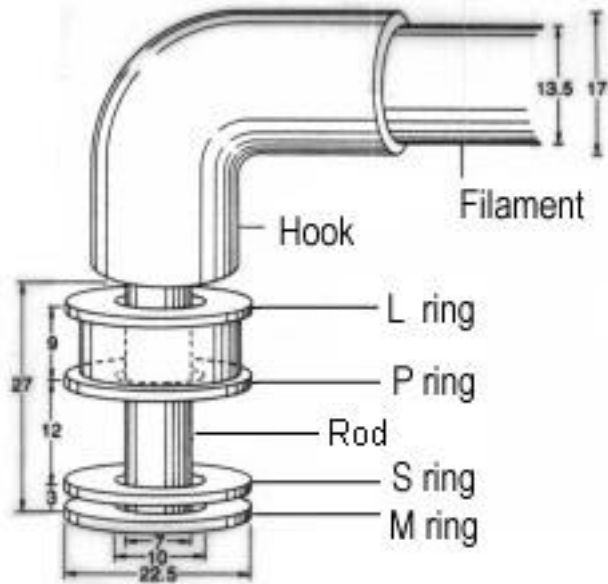

The bacterial flagellum of the *E. coli* bacteria has a motor structure of drive shaft, rotor, bushings, propeller, and a rotational speed of about 20,000 rpm

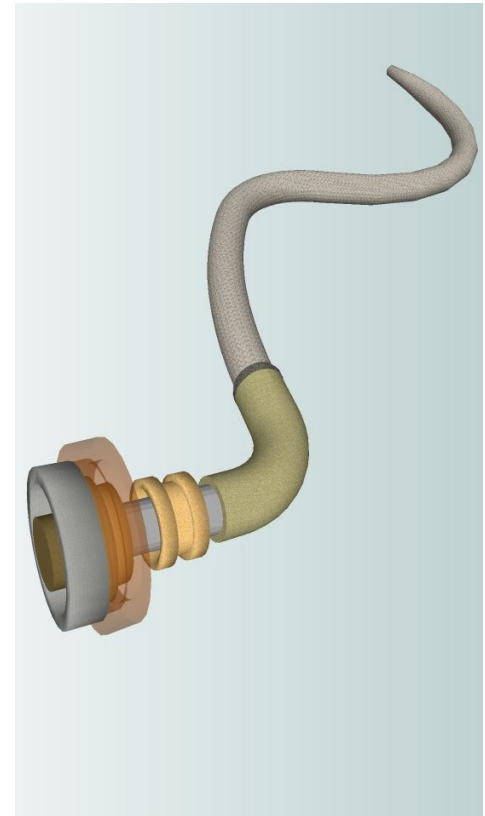

Miller-Urey Experiment

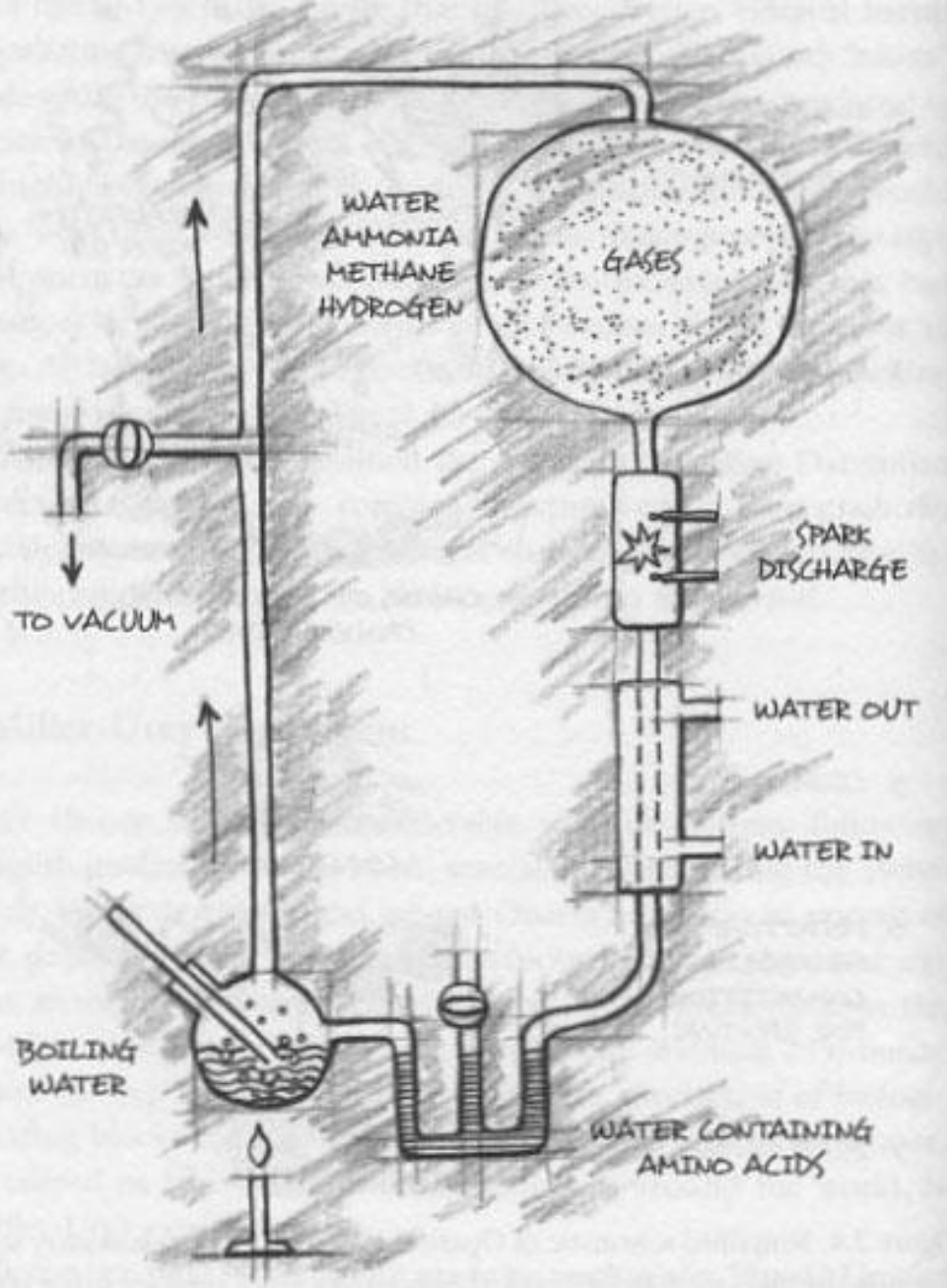

Has many problems, including:

1. Conditions that create amino acids rapidly destroy proteins
2. Had to start with pure compounds not normally found in life
3. Had to carefully control how energy was added to the system
4. Had strategic trap to remove products before they were destroyed
5. Produced both left and right-handed forms

Simulation experiments have not produced life

Chance origin of life?

- There are 10^{80} atoms in the entire universe
- Getting one functional protein by chance in a primordial soup is 1 in 10^{164}
- Producing the proteins necessary to service a one-cell organism by chance is 1 in $10^{40,000}$

**Probability of building a minimally complex cell
by chance is zero!
(there are not enough probabilistic resources)**

Spontaneous formation of life ?

What are the chances of life spontaneous forming on earth?
According to Hoyle and Wickramasinghe, $10^{40,000}$ to 1. As a reference point there are “only” 10^{80} atoms in the entire universe!

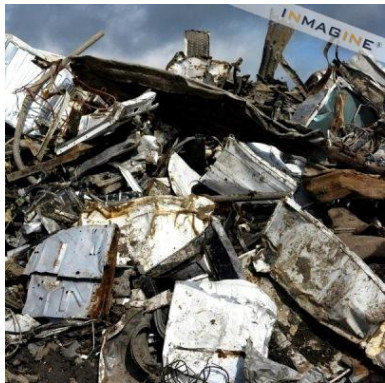

+



?
=



About as likely as a tornado going through a junkyard and assembling a running Boeing 747!

RNA World scenario

The most popular theory of how life began

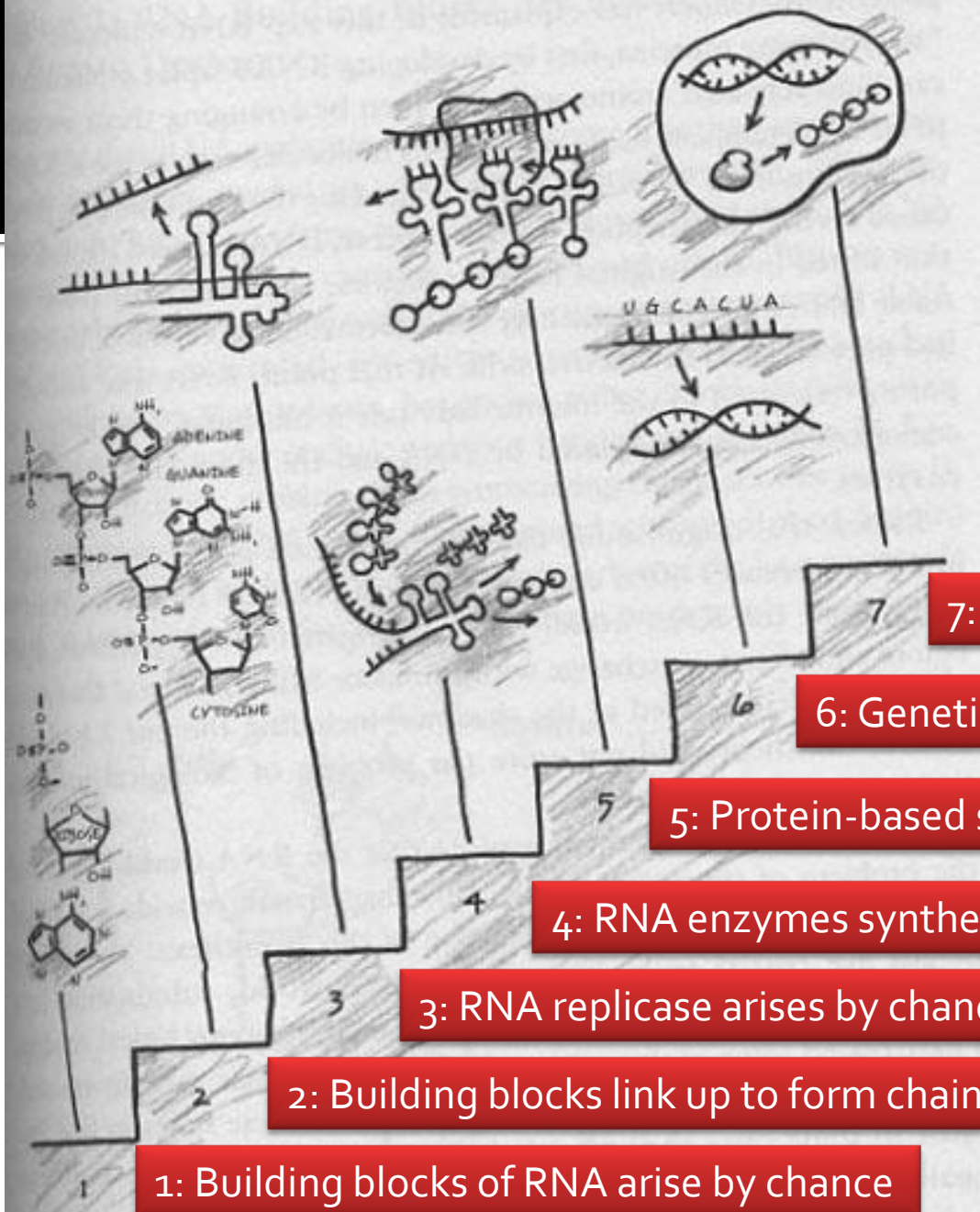

Problems with the RNA world

- 1. Doesn't explain the origin of genetic information**
- 2. RNA building blocks are hard to make and easy to destroy**
- 3. RNA molecules possess very few of the useful properties of proteins**
- 4. No explanation of how self-replicating RNA evolved into modern cells that rely on proteins**
- 5. Engineered RNA molecules don't simulate undirected chemical evolution**

The LORD God formed the man from the dust of the ground and breathed into his nostrils the breath of life, and the man became a living being
-- *Genesis 2:7*

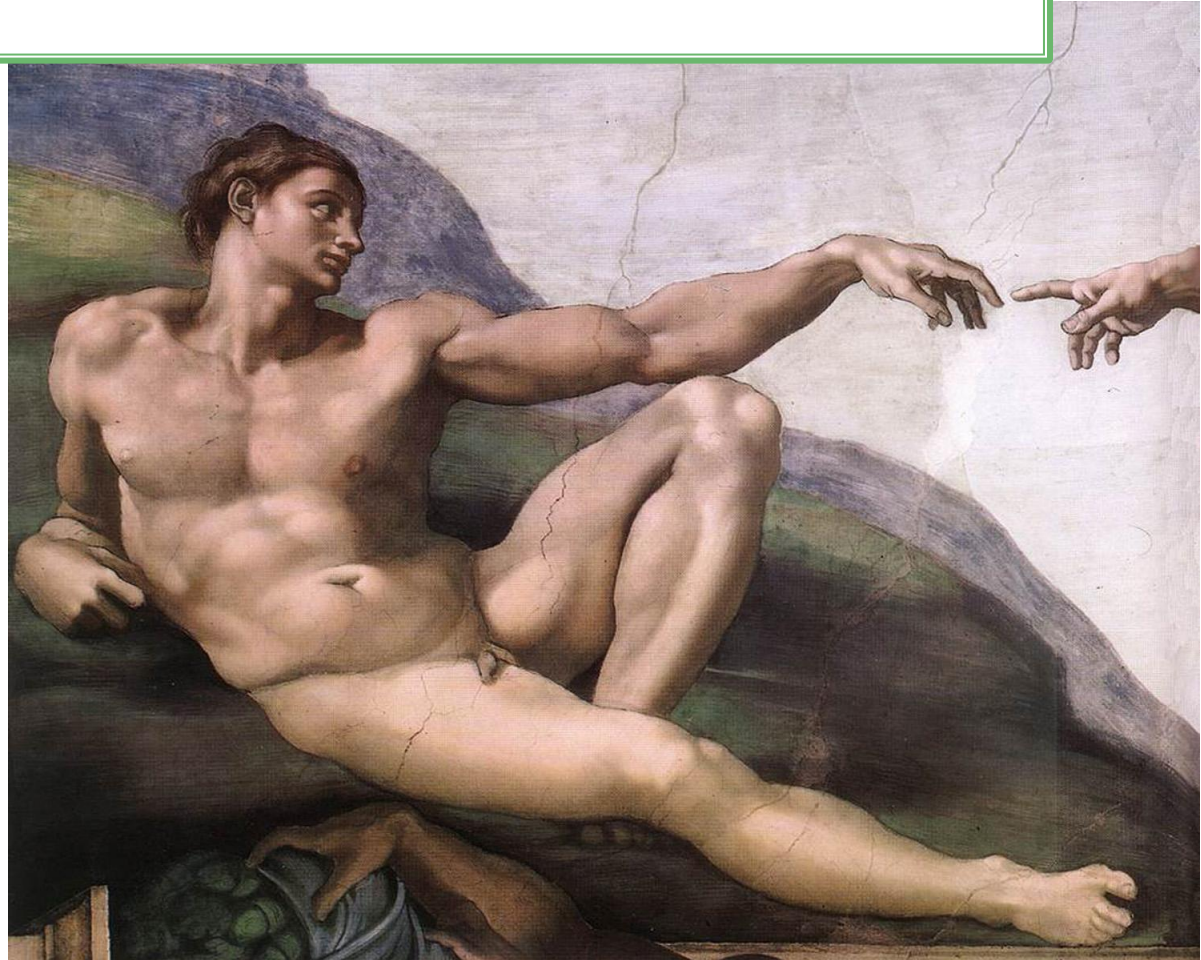

#4: Design and Beauty of Living Things

- The intricate design seen in nature demands a designer
- The example of the Monarch Butterfly life cycle proves Darwin wrong
- Beauty reflects God and is unexpected by evolution which is driven only by survival of the fittest
- Hurtful things in nature are the result of the Fall of man and God's curse on the earth

Not living, but obviously designed



Is this a natural rock formation?



William Paley watch analogy



If it could be demonstrated that any complex organ existed, which could not possibly have been formed by numerous, successive, slight modifications, my theory would absolutely break down. But I can find out no such case.

Charles Darwin - Origin of Species (1859)

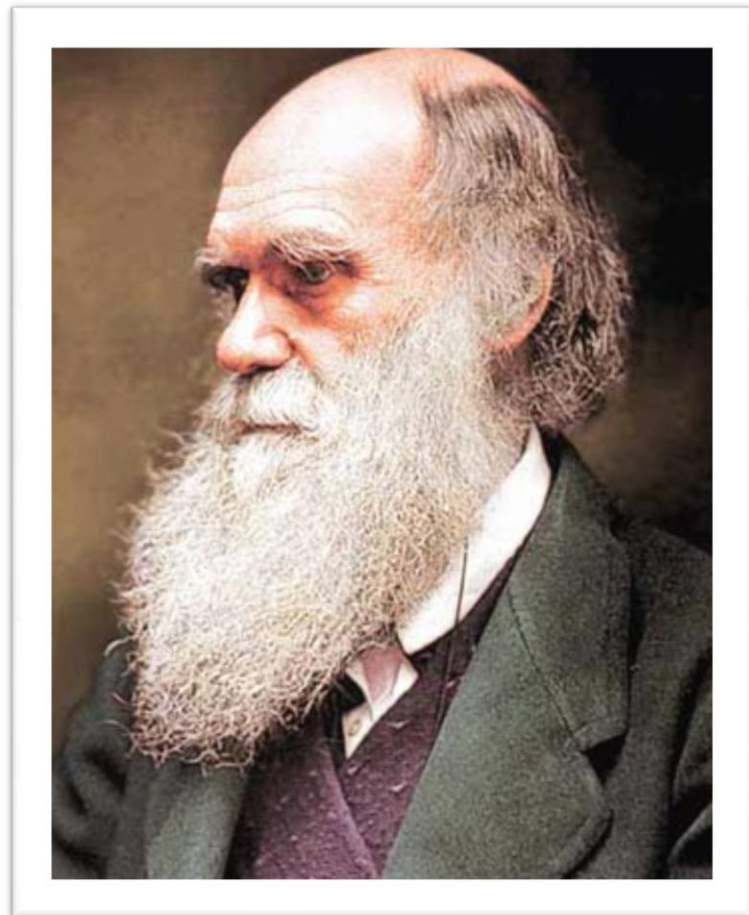
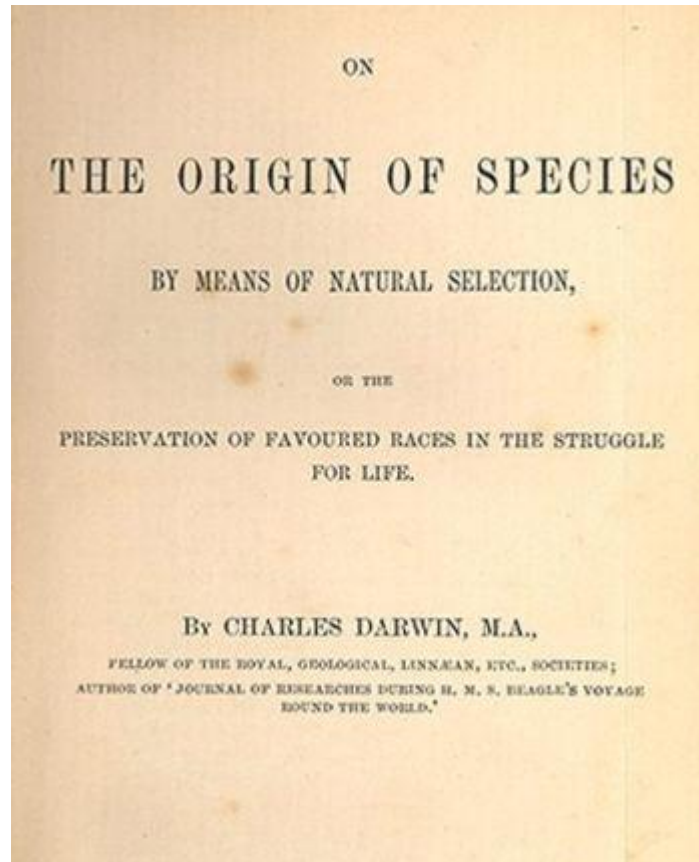

Monarch Butterfly Metamorphosis

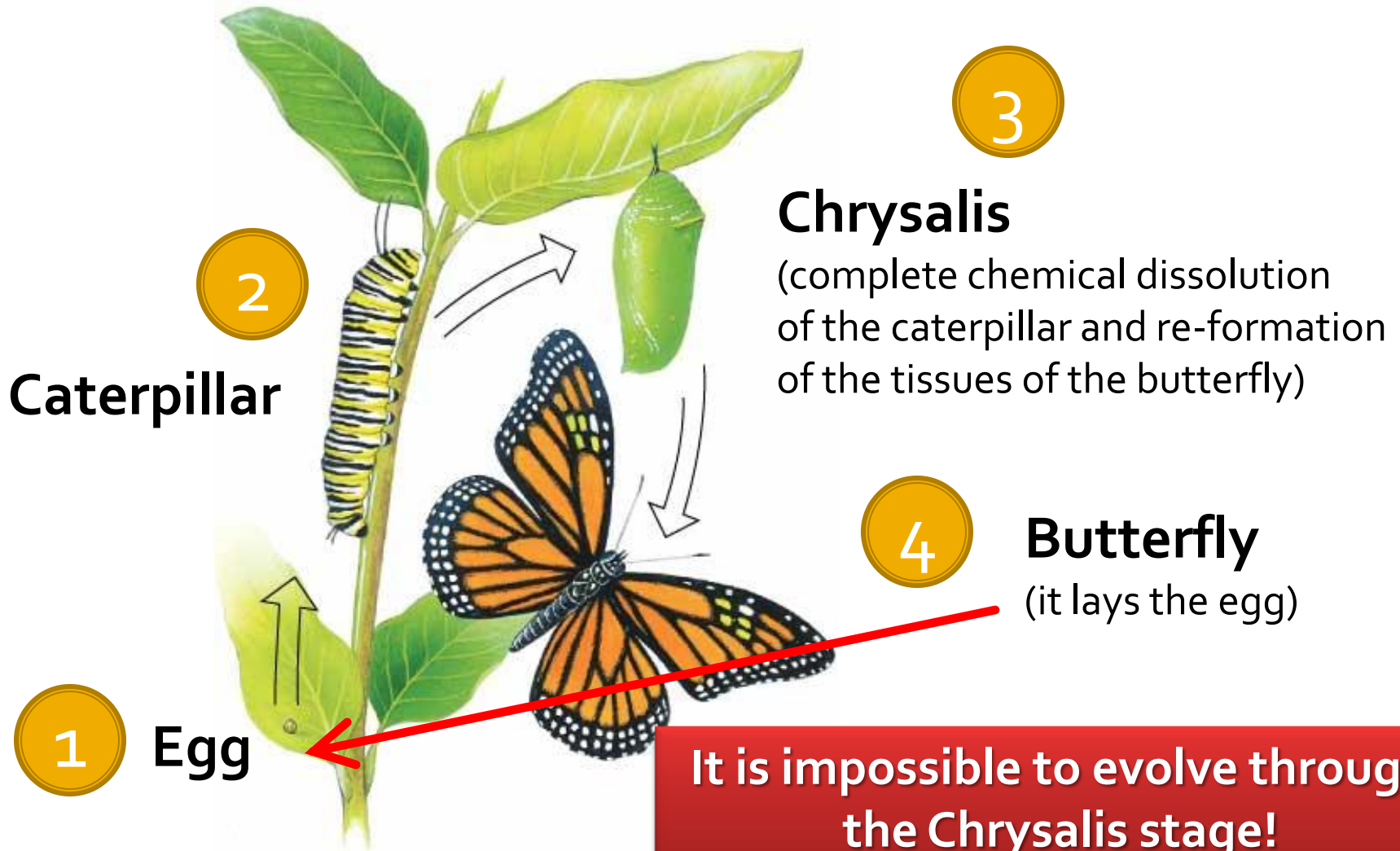

It is impossible to evolve through the Chrysalis stage!

Monarch Butterfly migration

Has a brain the size of a pinhead and yet migrates to a location 3,000 miles away and navigates there with an accuracy of 100 feet



The Bombardier Beetle



Defends itself by squirting predators with a high-pressure jet of boiling liquid, involving several complex chemical reactions!

Beauty reflects God and is unexpected by evolution



#5: Second Law of Thermodynamics

- Things naturally mix and decay over time
- Evolution proposes the opposite, increasing order and complexity over time
- Machinery is needed to overcome this law by harnessing and directing energy for a purpose - evolution has no such machinery

Time's Arrow

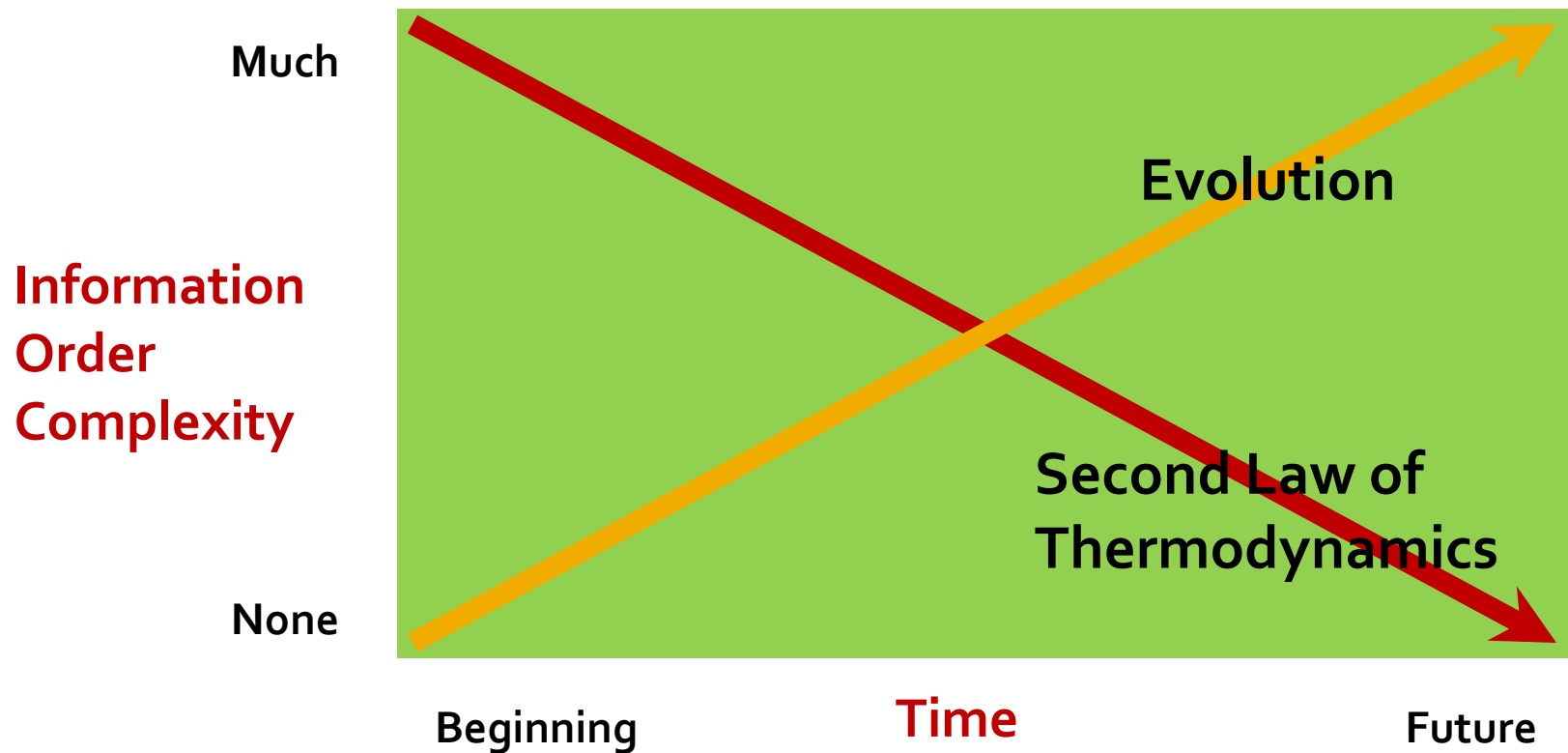

Evolution runs contrary to “Time’s Arrow” - we know from the Second Law of Thermodynamics that the universe is “running down”, yet evolution postulates just the opposite!

Everything wears out

They [the earth and the heavens] will perish, but you [God] remain; they will all wear out like a garment. *Hebrews 1:11*

Describes the “Second Law of Thermodynamics” - the universal principle that everything is “mixing together” and decaying



#6: Irreducible Complexity

- Means “Nothing works until everything works”
- Biological structures in the cell exhibit irreducible complexity
- Evolution cannot produce functioning complex structures in a single generation, and partial useless structures would be selected away as evolution has no foresight

Irreducible Complexity: Take away one part and it doesn't work

A mousetrap has:

- Platform / Base
- Spring
- Hammer
- Catch
- Holding Bar

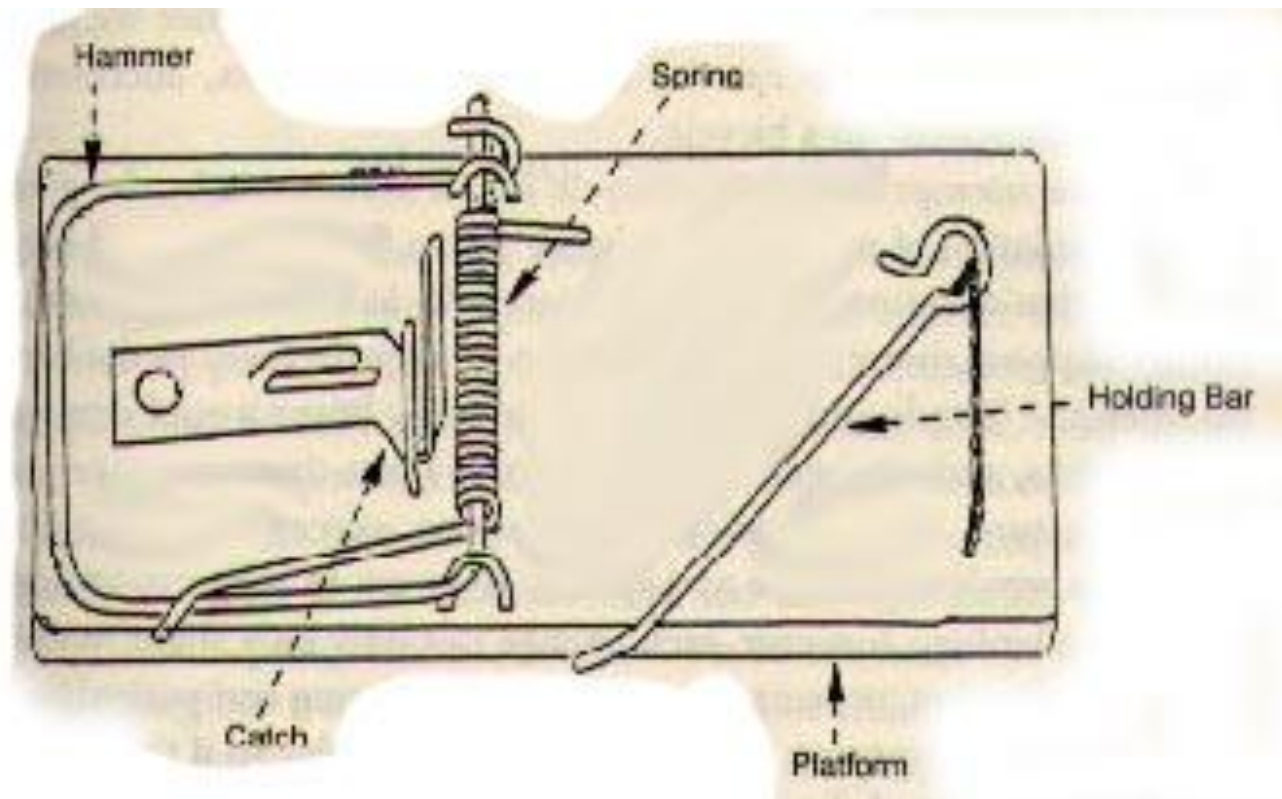

Take one part away
and it will no longer function as a mousetrap!

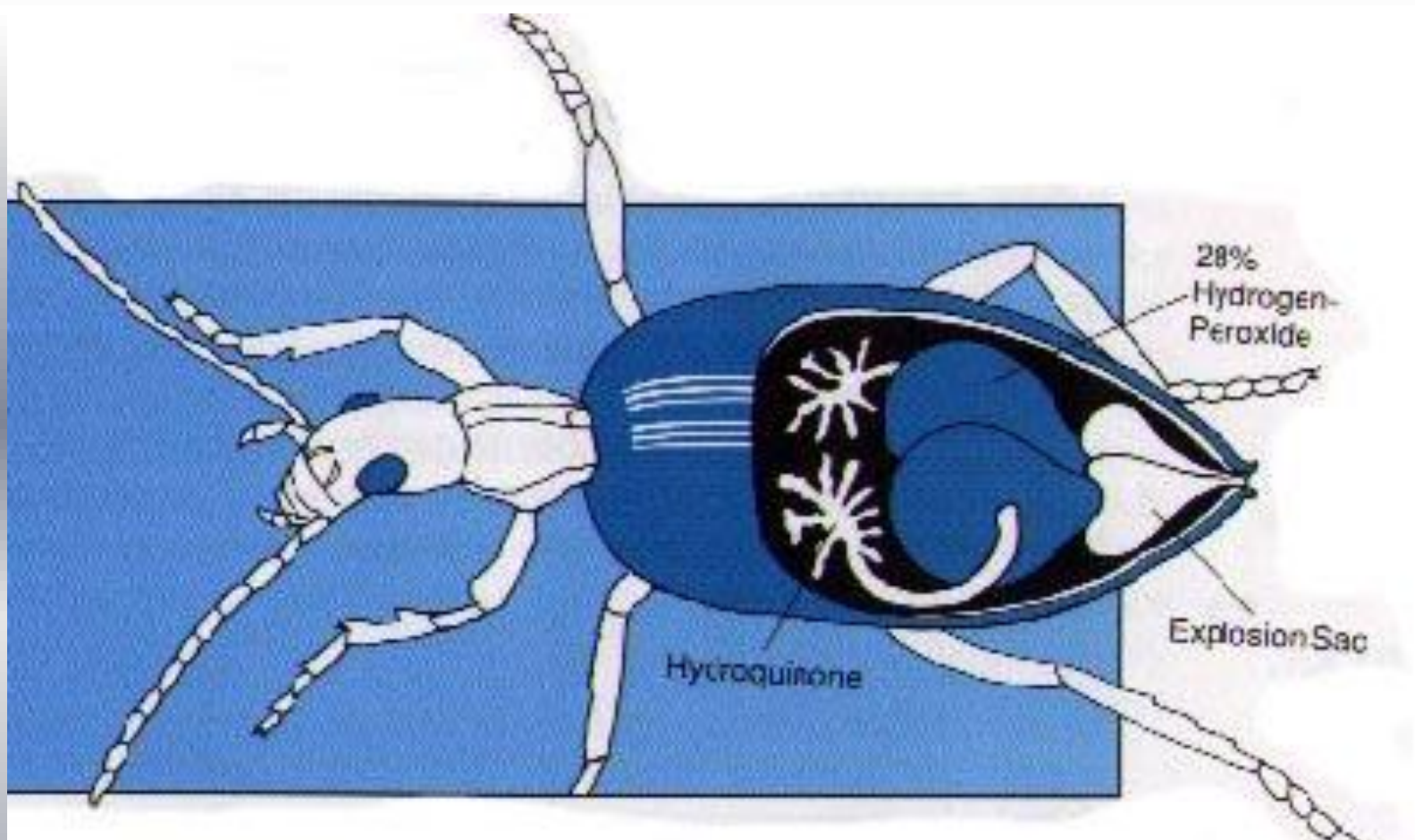

**The beetle has twin chambers in which he stores two chemicals.
He also makes an inhibitor which prevents them from reacting with each other when mixed.**

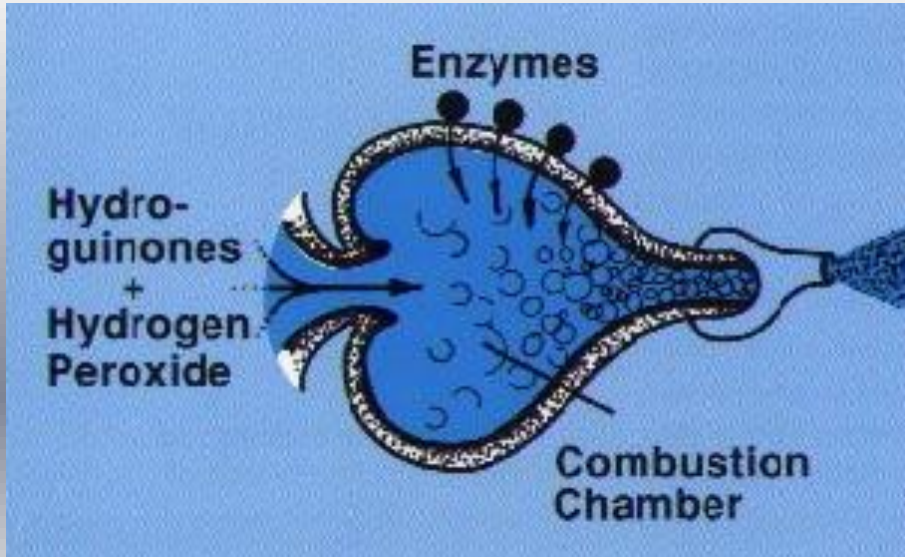

When threatened, he squirts the chemicals into a combustion chamber.

Two enzymes are added causing the mixture to get very hot, which builds up pressure. The beetle then opens a valve to release the gas at his enemy!

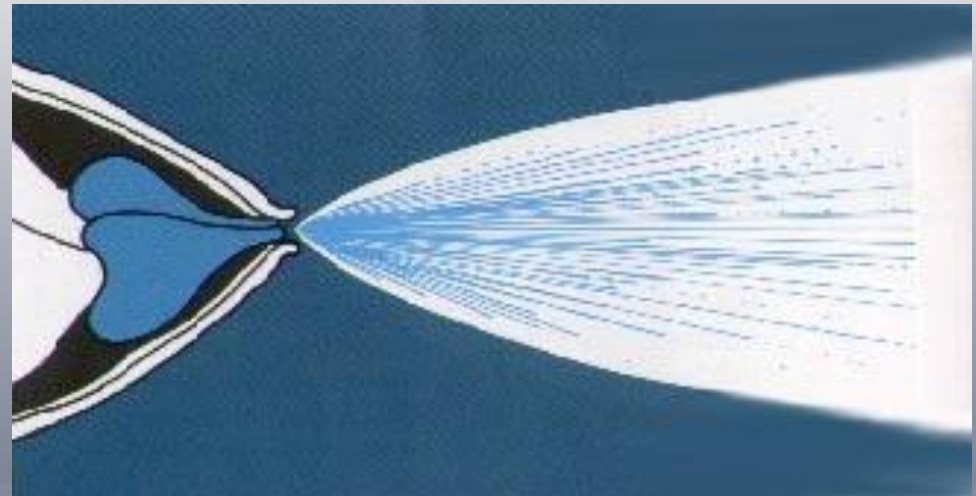

Unless all these pieces are in place and working together this is what would happen!



The problem with evolution is:



**Nothing Works
Until
Everything Works!**

Best evidence for evolution?

According to Stephen Jay Gould (1941-2002)
Influential evolutionary biologist and author

- We see “micro-evolution” and natural selection
 - BUT... Limited adaptive ability is a design feature
 - Artificial breeding always hits a limit
 - Change is limited by existing information
- The fossil record
 - BUT... It is also the expected result of a global flood
 - Abrupt appearance is always seen
- Imperfections in nature
 - BUT... This is explained by God’s curse on the Earth

So far we see...

God-Creation

Evolution

Information
Design
Fine-tuning
Fossil record
MORE TO
COME

Micro-evolution
Fossil record
Imperfections

Reality

Myth

Part 2 NEXT TIME

- 7. Existence of the Universe**
- 8. Fine-tuning of Physics**
- 9. Fine-tuning of Earth for Life**
- 10. Abrupt Appearance in the Fossil Record**
- 11. Human Consciousness and Language**
- 12. Human Reasoning and Logic**
- 13. Sexual Reproduction**
- 14. Morality**
- 15. Miracles**

How to become a Christian

The Gospel message = “Good News”!

- **A = Admit** (I am a sinner)
 - God demonstrates His own love for us in this: while we were still sinners, Christ died for us. (Romans 5:8)
- **B = Believe** (that Jesus died for your sins – He is the Savior)
 - To all who received Him, to those who believed in His name, He gave the right to become children of God. (John 1:12)
- **C = Confess** (that Jesus is Lord)
 - If you confess with your mouth, ‘Jesus is Lord,’ and believe in your heart that God raised Him from the dead, you will be saved. (Romans 10:9)

